

Jøtul C 24 con telaio ampio opzionale incluso

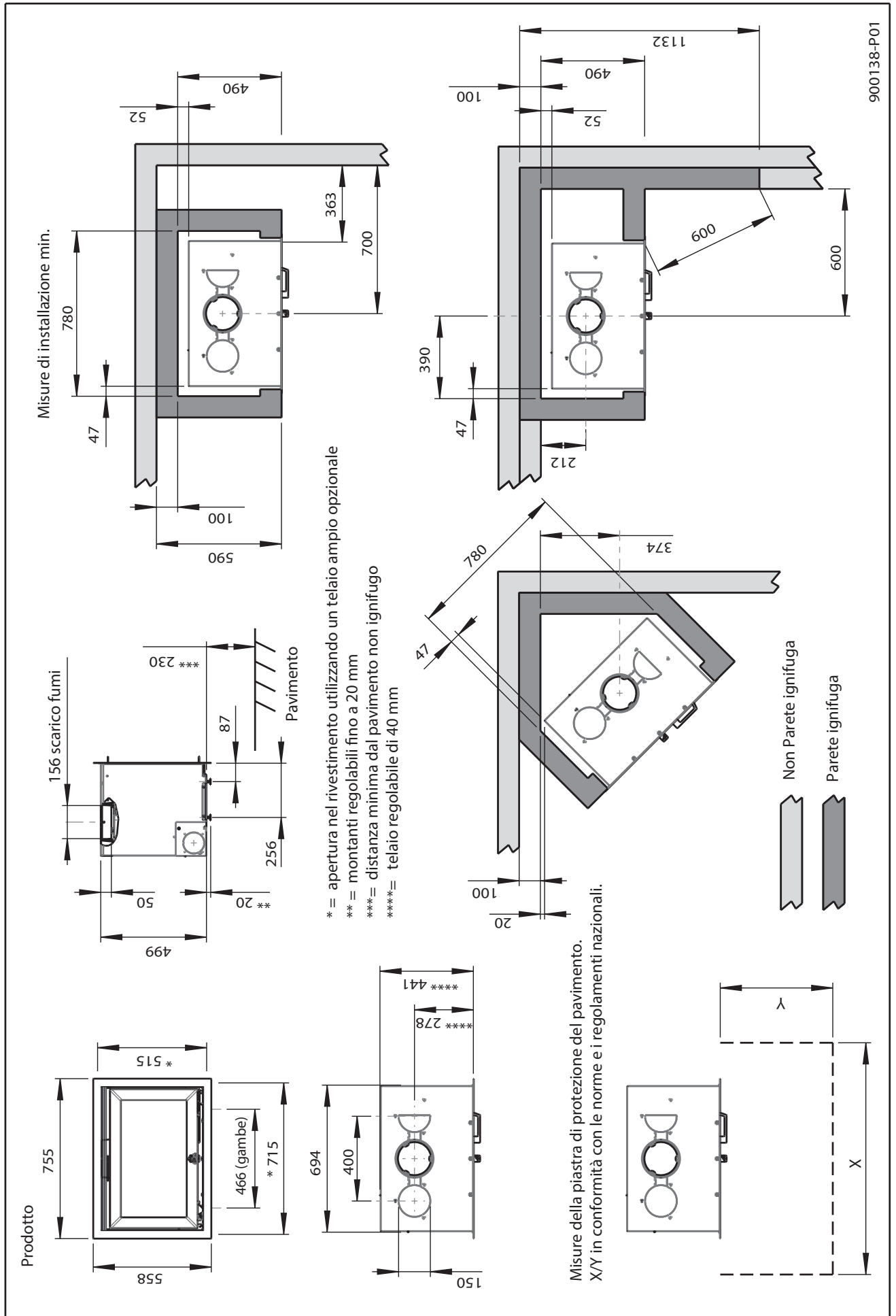

Fig. 1 a

Jøtul C 24 IT con telaio stretto opzionale incluso

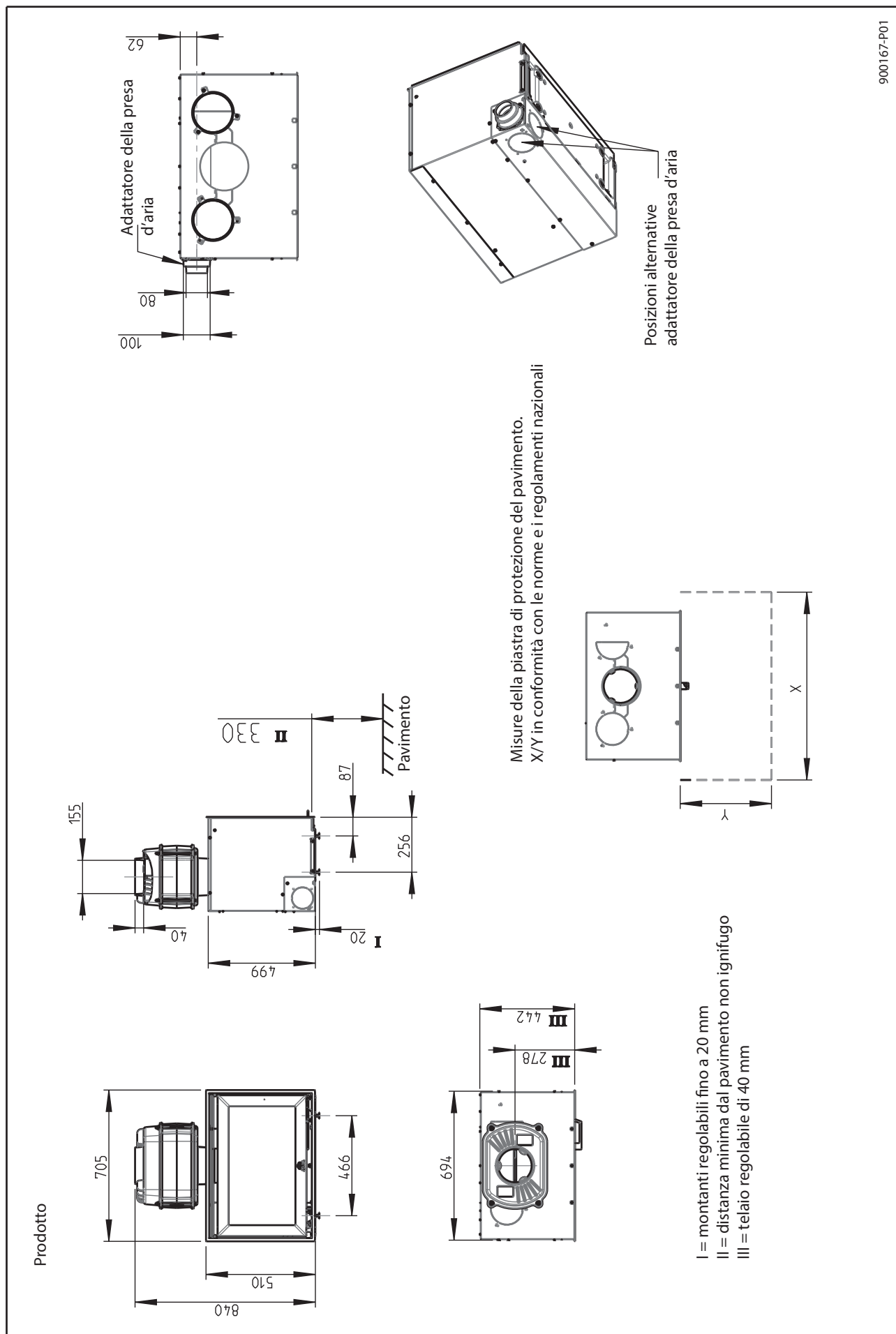
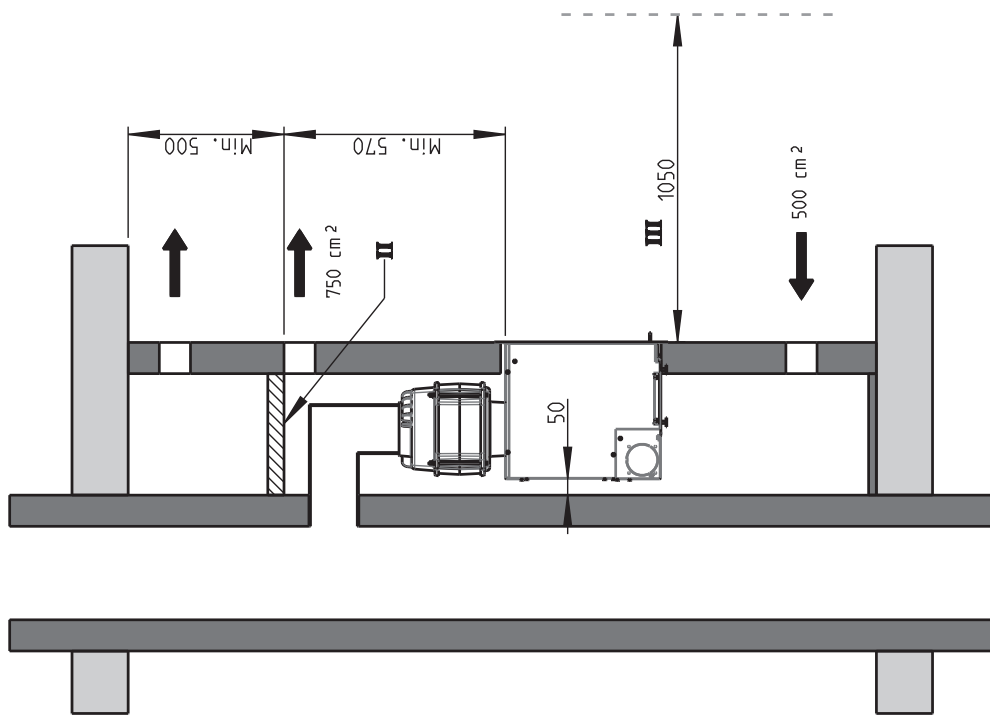
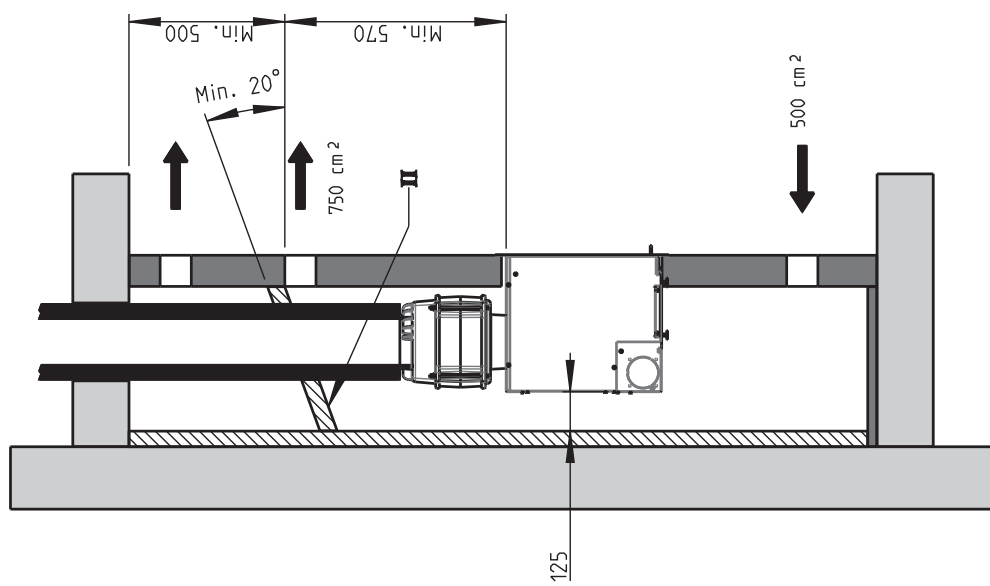

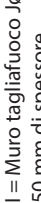



Fig. 2



I = isolamento alternativo. Vedere capitolo 4.3
 II = utilizzare una piastra d'acciaio sotto all'isolamento se necessario
 III = Distanza dai mobili (combustibile)

-  I = Muro tagliafuoco Jøtul JGFW-5
50 mm di spessore
-  Canna fumaria isolata
-  Materiale combustibile
-  Materiale noncombustibile

900167-P01